

UTS SALES AND REPAIRS

MANUFACTURER OF ALUMINIUM ACCESS EQUIPMENT

UTS FOLDOUT TOWER MANUAL

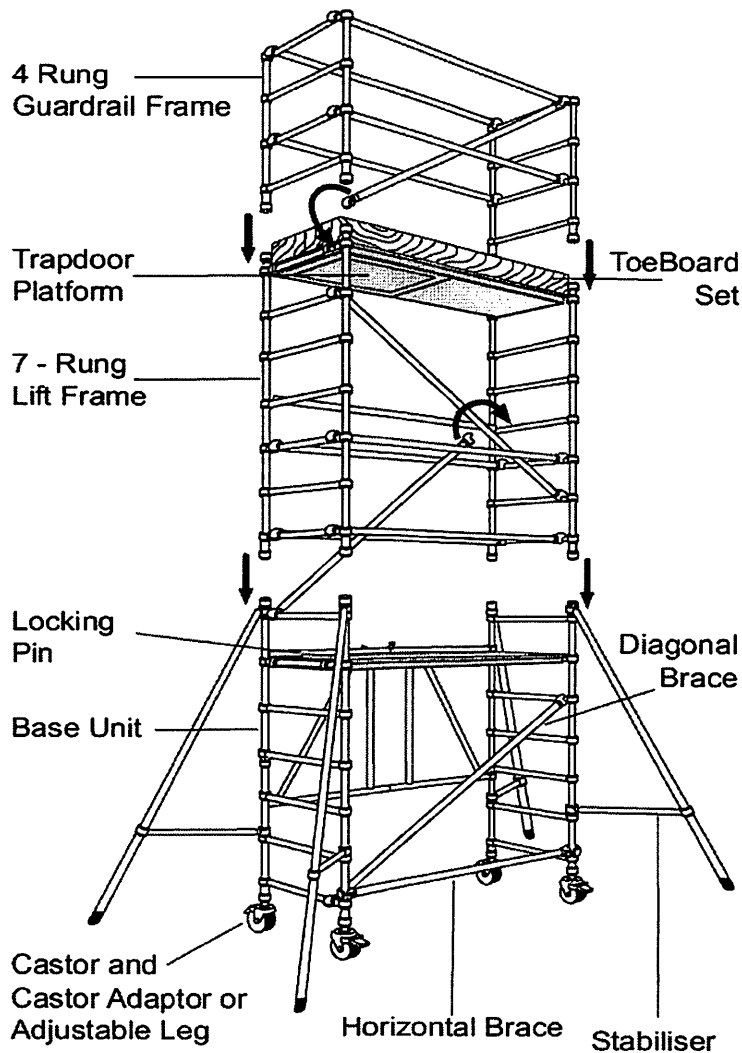

OAR FARM BARN, BROOKE LANE
HERNE BAY, KENT
CT6 6TT

TEL NUMBER: 0333 1234210
EMAIL: INFO@UTSSALESANDREPAIR.CO.UK
WEBSITE: WWW.UTSSALESANDREPAIR.CO.UK

SAFETY FIRST

Mobile Towers - 3T Method

INTRODUCTION

Please read this guide carefully.

Please note that diagrams are for illustrative purposes only. User guides are also available to download from our website at utssalesandrepair.co.uk

UTS mobile aluminium towers are light-weight scaffold towers used throughout the building and construction industry for both indoor and outdoor access solutions where a stable and secure platform is required.

Ideal for maintenance and installation work or short-term access, the highly versatile towers provide a strong working platform for a variety of heights.

This User Guide provides you with step by step instructions to ensure your system is erected easily and safely, using the 3T (Through The Trapdoor) method. The law requires that personnel erecting, dismantling or altering towers must be competent. Any person erecting a UTS mobile tower must have a copy of this guide.

For further information on the use of mobile access and working towers consult the PASMA operators code of practice.

If you need further information, design advice, additional guides or any other help with this product, please contact UTS Sales and Repairs Ltd 01227 860085 or email info@utssalesandrepair.co.uk

PREPARATION AND INSPECTION

Inspect the equipment before use to ensure that it is not damaged and that it functions properly. Damaged or incorrect components shall not be used.

- Check that all components are on site, undamaged and that they are functioning correctly – (refer to Checklist and Quantity Schedules). Damaged or incorrect components shall not be used.
- Check if the ground on which the mobile access tower is to be erected and moved is capable of supporting the tower.
- The safe working load is 275 kgs (606lbs), per platform level, uniformly distributed up to a maximum of 750kgs per tower.
- Towers must always be climbed from the inside during assembly and use.
- It is recommended that towers should be tied to a solid structure when left unattended.
- Adjustable legs should only be used for levelling.

LIFTING OF EQUIPMENT

Tower components should be lifted using a reliable lifting material (e.g. strong rope), employing a reliable knot (e.g. clove hitch), to ensure safe fastening and always lift within the footprint of the tower. Assembled mobile towers should not be lifted with a crane or other lifting device.

STABILISERS / BALLAST

Stabilisers and ballast weights shall always be fitted when specified.

The Quantity Schedules show the recommended stabilisation. In circumstances where there is restricted ground clearance for stabilisers, contact your supplier for advice. Ballast must be of solid materials (i.e. not water or loose sand) and should not be positioned to overload individual legs. Ballast should be secured against accidental removal where practicable, and be supported on the lowest rung of the bottom frame.

MOVEMENT

The tower should only be moved by manual effort, and only from the base. When moving the tower, beware of live electrical apparatus, particularly overhead, plus wires or moving parts of machinery. No person or materials should be on the tower during movement.

Caution should be exercised when wheeling a tower over rough, uneven or sloping ground, taking care to unlock and lock castors. If stabilisers are fitted, they should only be lifted a maximum of 25mm above the ground to clear ground obstructions. The overall height of the tower when being moved, should not exceed 2.5 times the minimum base dimensions, or 4 metres overall height.

Before use, check the tower is still correct and complete. After every movement of the tower use a spirit level to check that it is vertical and level and set the adjustable legs as required. Do not move the tower in wind speeds over 7.7 metres per second (17mph).

DURING USE

Beware of high winds in exposed, gusty or medium breeze conditions. We recommend that in wind speeds over 7.7 metres per second (17 mph), cease working on the tower and do not attempt to move it. If the wind becomes a strong breeze, expected to reach 11.3 metres per second (25 mph), tie the tower to a rigid structure. If the wind is likely to reach gale force, over 18 metres per second (40 mph), the tower should be dismantled.

| Wind | Beaufort Scale 10 Metres above ground | Force | Speed in m.p.h. | Speed in knots |
|-----------------|--|-------|-----------------|----------------|
| Moderate Breeze | Raises dust and loose paper, small branches move. | 4 | 13–18 | 11–16 |
| Strong Breeze | Large branches in motion, telegraph wires whistle. | 6 | 25–31 | 22–27 |
| Gale Force | Walking is difficult, twigs break off trees. | 8 | 39–46 | 34–40 |

Beware of open ended buildings, which can cause funnelling effect. Do not abuse equipment. Damaged or incorrect components shall not be used. Raising and lowering components, tools, and/or materials by rope should be conducted within the lower base. Ensure that the safe working load of the supporting decks and the tower structure is not exceeded.

The assembled tower is a working platform and should not be used as a means of access or egress to other structures.

Beware of horizontal forces (e.g. power tools) which could generate instability. Maximum horizontal force 20 kg. Mobile towers are not designed to be suspended - please refer to your supplier for advice.

Do not use boxes or stepladders or other objects on the platform to gain extra height.

TIES

- Ties should be used when the tower goes beyond its safe height, beyond the limits of the stabilisers/outriggers, or if there is a danger of instability. They should be rigid, two way ties fastened to both uprights of the frame with load bearing right angled or swivel couplers. Only couplers suitable for the 50.8mm diameter tube of the tower should be used. Ideally, ties should be secured to both faces of a solid structure by means of anchorages.
- The tie frequency may vary depending on the application, but they should, at a minimum, be every 4 metres height.
- For further information on tying-in a tower please contact your supplier or UTS.

MAINTENANCE - STORAGE - TRANSPORT

- All components and their parts should be regularly inspected to identify damage, particularly to joints. Lost or broken parts should be replaced, and any tubing with indentation greater than 5mm should not be used and put to one side for manufacture repair. Adjustable leg threads should be cleaned and lightly lubricated to keep them free running.
- Brace claws, frame interlock clips, trapdoor latches and platform windlocks should be regularly checked to ensure they lock correctly.
- Refer to the UTS Inspection Manual for detailed inspection and maintenance advice
- Components should be stored with due care to prevent damage.
- Ensure components are not damaged by excessive strapping forces when transported.

COMPONENTS

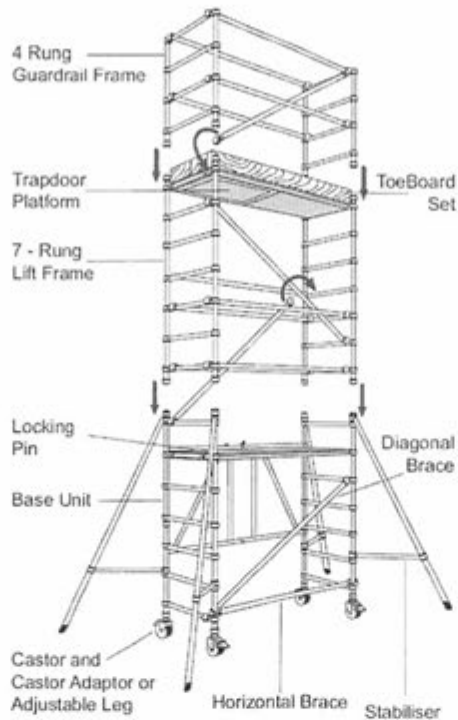

QUANTITY SCHEDULE

| PLATFORM HEIGHT | 0.8M | 1.8M | 2.5M | 3.5M | 4.3M | 5.3M | 6.05M |
|-----------------|------|------|------|------|------|------|-------|
| WORKING HEIGHT | 2.8M | 3.8M | 4.5M | 5.5M | 6.3M | 7.3M | 8.05M |
| COMPONENTS | | | | | | | |
| BASE UNIT | 1 | 1 | 1 | 1 | 1 | 1 | 1 |
| 7 RUNG FRAME | 0 | 0 | 2 | 2 | 4 | 4 | 6 |
| 4 RUNG FRAME | 0 | 2 | 0 | 2 | 0 | 2 | 0 |
| 1.8M TRAP DECK | 1 | 1 | 2 | 2 | 2 | 2 | 2 |
| 1.8M BRACE | 3 | 5 | 7 | 7 | 7 | 9 | 7 |
| 2.1M BRACE | 0 | 1 | 2 | 4 | 4 | 5 | 6 |
| S1 STABILISER | 0 | 0 | 4 | 4 | 4 | 4 | 4 |
| TOEBOARD SET | 1 | 1 | 1 | 1 | 1 | 1 | 1 |

ASSEMBLY

When erecting a UTS FOLD OUT TOWER:

To comply with the Work at Height Regulations, guardrails are positioned in advance of climbing onto a platform to reduce the risk of fall.

- All platforms feature double guardrails on both faces of the tower.
- All guardrails should be 2 and 4 rungs (0.5m and 1.0m) above platforms.
- Position handrails 4 rungs above platform level.
- Position intermediate handrails 2 rungs above platform level.
- Never stand on an unguarded platform positioned above the second rung of a tower. if your risk assessment shows it necessary you may also need to guardrail platforms at this level.

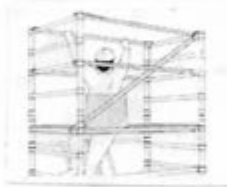

To Dismantle a UTS FOLD OUT TOWER:

- Remove toeboards, and pass down the tower.
- Unclip farthest end of braces and immediately move to protected trapdoor position on ladder to complete removal.
- Remove upper platforms from protected levels below.
- Pass removed components out of the tower to a colleague.

ASSEMBLY PROCEDURE

Mobile Towers - 3T Method

HEIGHT 1 - PLATFORM 0.8M

1 Insert the 4 castors into the adjustable legs and then lay the folded base unit on its side to insert the adjustable legs into the bottom of the base unit

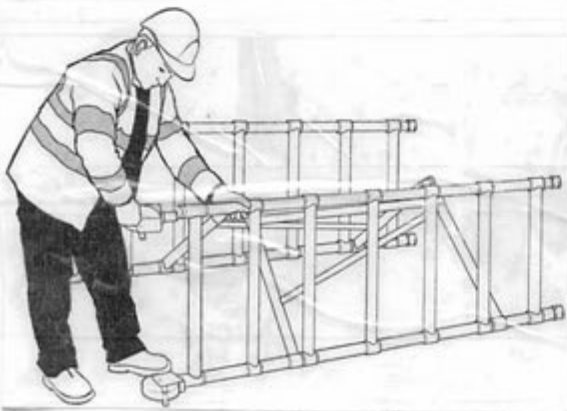

2 Stand the base unit up and push the central hinged frame outwards until flat. Unfold the two end frames. Insert the locking pin into the top centre hinge joint. Lock the castor Brakes.



Check the ground is flat and all four castor wheels are in contact with the ground. Use a spirit level to check the base unit level.

IMPORTANT. Only use the adjustable legs to level the tower and not to gain extra height.

3 Fit a horizontal brace (red) as a guardrail on the top (7th) rung, on the hinged frame side of base unit. **IMPORTANT.** Always ensure braces are fully locked in position.



4 Position a platform on the 3rd rungs of the Base unit. Do not position above the 3rd rung. Engage the windlocks, underneath the rungs, at both ends of the platform.

5 Climb onto the platform in the sequence shown. From the seated position, fit horizontal braces as guardrails on the 5th and 7th rungs on the open side of the base unit. Do not stand on the platform until the guardrails are in place.

IMPORTANT Always ensure braces are fully locked in position.

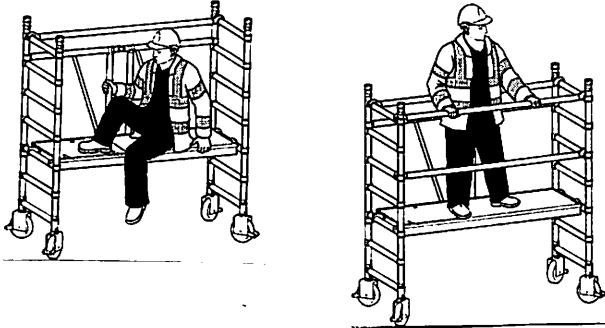

6 If your risk assessment shows it is necessary, fit a set of toeboards to the platform. Check there are no gaps through which any materials could fall and that the trapdoor opens correctly.

IMPORTANT. Never climb up the outside of the Base Unit. Never over reach – get down and reposition the Base Unit.

The tower is now complete.

Height 2 - Platform 1.8m

1 Assemble the base unit as shown in steps 1 and 2 on page 5-6

2 Fit a horizontal (red) brace between the verticals, just above the 1st rung, on the open side of the tower.

IMPORTANT. Always ensure braces are fully locked in position.

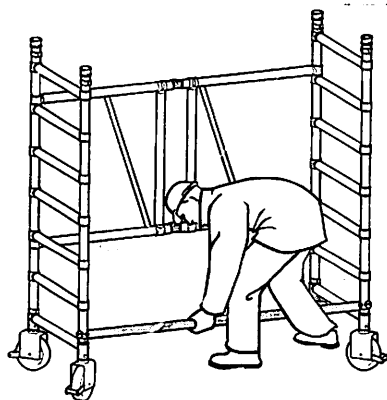

3 Position a temporary platform on the 2nd rungs of the tower. Engage the wind locks, underneath the rungs, at both ends of the platform. Fit a four rung guardrail frame to each end of the base unit. Ensure the 4 rung frame interlock clips are engaged.

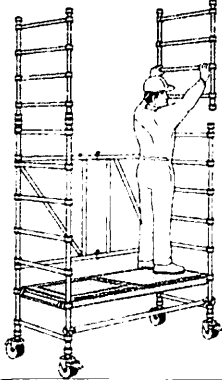

4 Reposition the temporary platform to the 7th rung of the tower. Ensure the windlocks are engaged, at both ends of the tower. Fit a diagonal brace (blue) on the open side of the tower, between the 7th and 11th rungs. If the tower is being used externally fit 4 stabilisers to the tower.

Refer to the stabilisers section on page 14 for guidance on positioning stabilisers.

Climb the tower on the inside using the rungs of the end frames. From a protected position within the trapdoor, fit 4 horizontal braces as guardrails, 2 and 4 rungs above the platform (the 9th and 11th rungs of the tower), on both sides of the tower.

IMPORTANT. Always ensure braces are fully locked in position.

NEVER stand on the platform until the guardrail braces are in place.

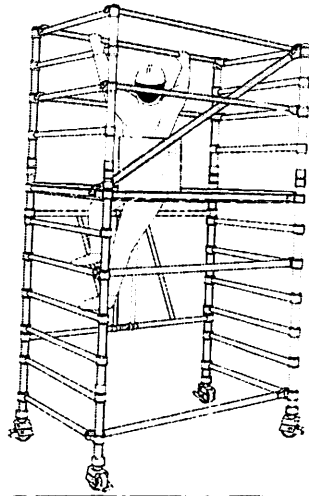

HEIGHT 3,5,6- Platform 2.5m, 4.3m & 6.05m

1 Assemble the base unit as shown in steps 1 and 2 of Height 1 (0.8m) build method. See page 5-6

2 Position a temporary platform on the 2nd rungs of the tower. Engage the wind locks, underneath the rungs, at both ends of the platform.

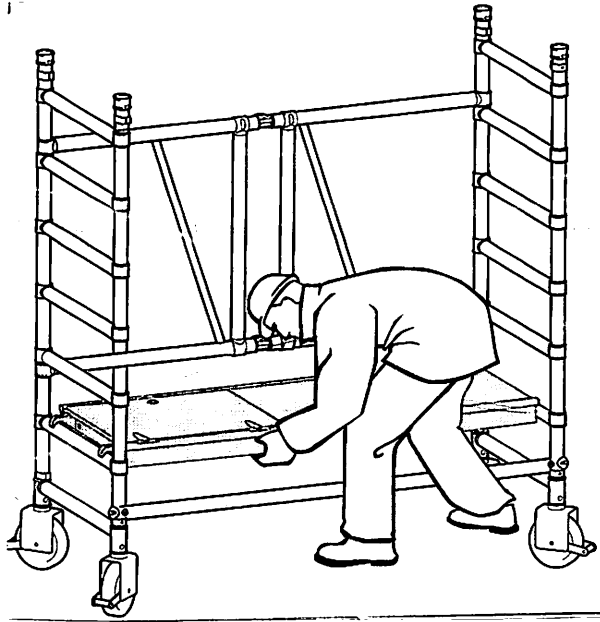

3 Fit a 7 rung lift frame to each end of the base unit. Ensure the 4 frame interlock clips are engaged. Fit a diagonal brace between the 3rd and 7th rungs on the open side of the tower. Fit another diagonal brace in the opposite direction to the lower diagonal, between the 7th and 11th rungs of the tower, as shown.

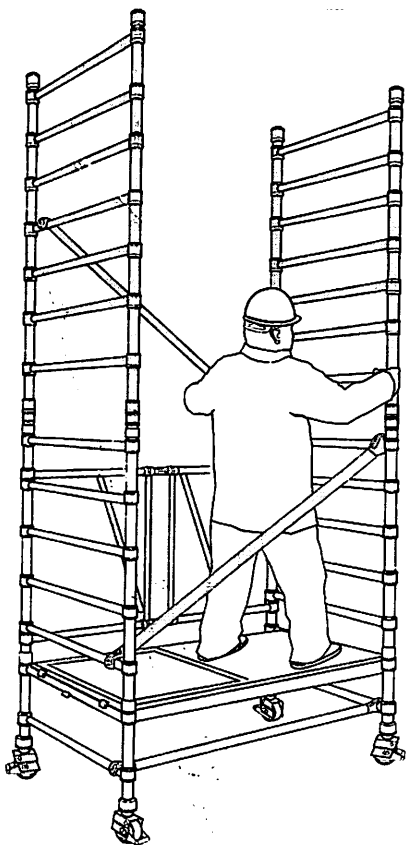

4 Fit a platform to the 10th rungs of the tower

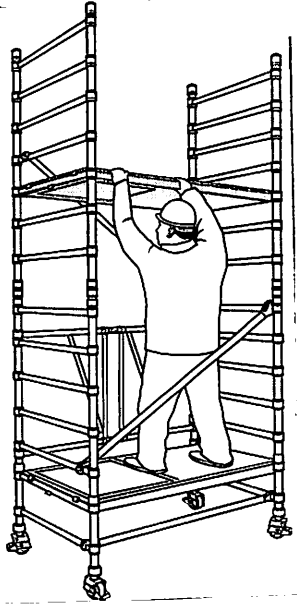

5 Fit 4 stabilisers to the tower.

Refer to Stabilisers Section on page 14 for guidance on positioning stabilisers.

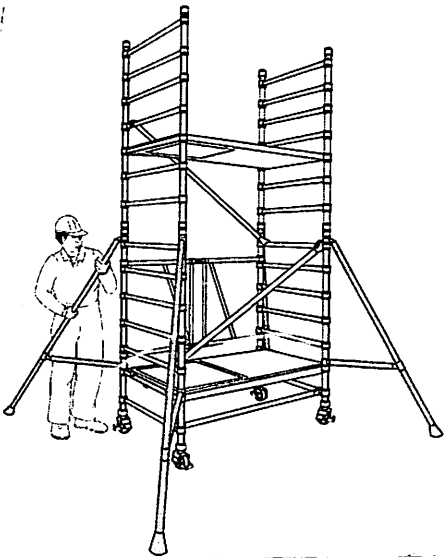

6 Climb the tower on the inside using the rungs of the end frame. From the protected trapdoor position, fit 4 horizontal braces as guardrails, 2 and 4 rungs above the platform (the 12th and 14th rungs of the tower) on both sides of the tower.

IMPORTANT. Always ensure braces are fully locked in position.

NEVER stand on the platform until the guardrail braces are in place.

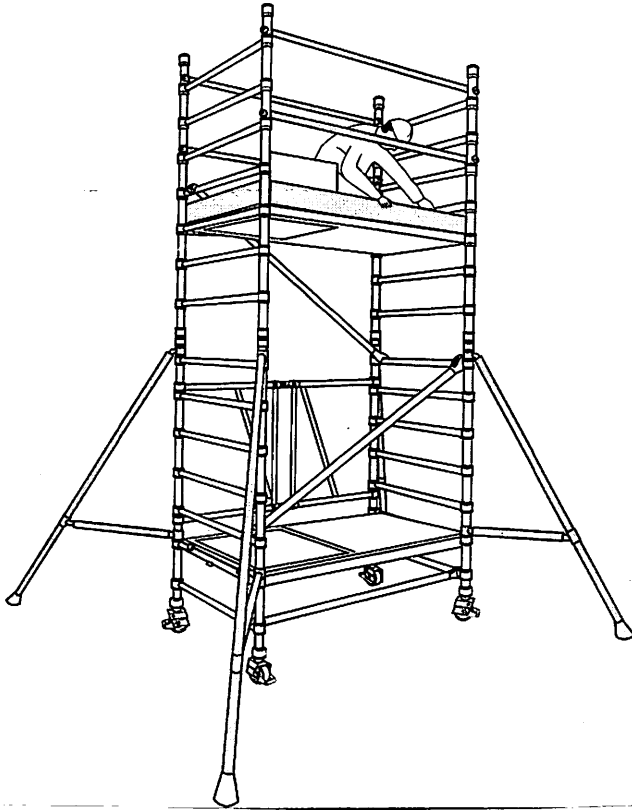

IF BUILDING TO 4.3m & 6.05m PLATFORM HEIGHT:

Continue to fit additional pairs of 7 rung lift frames, diagonal braces, horizontal guardrails and trapdoor decks. **DO NOT CLIMB ON TO THE PLATFORM UNTIL IT IS FULLY GUARDRAILED**

7 Fit a set of toe boards to the platform. Check there are no gaps through which any material could fall and that the trapdoor opens correctly.

The tower is now complete.

HEIGHT 4 - Platform 3.5m

For Height 4 the tower must be erected and platform levels repositioned as shown

1 Assemble the base unit as shown in steps 1 and 2 of Height 1 (0.8m) build method. See page 5-6

2 Fit a platform to the 10th rungs of the tower. Engage the wind locks, underneath the rungs, at both ends of the platform.

3 Fit a diagonal brace (blue) on the open side the tower between the 1st and 5th rungs.

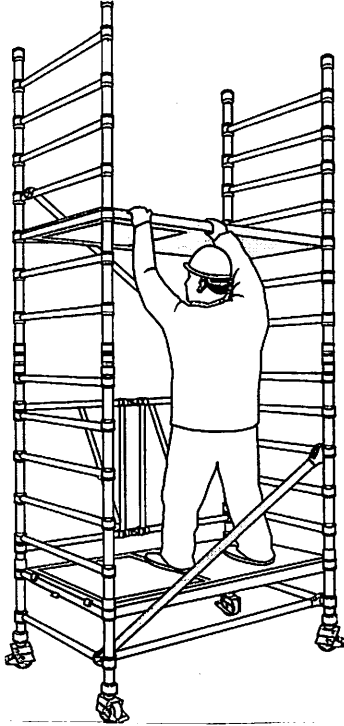

4 Climb the tower on the inside using the rungs of the end frames. From the protected trapdoor position, fit 4 horizontal braces as guardrails, 2 and 4 rungs above the platform (the 12th and 14th rungs of the tower) on both sides of the tower

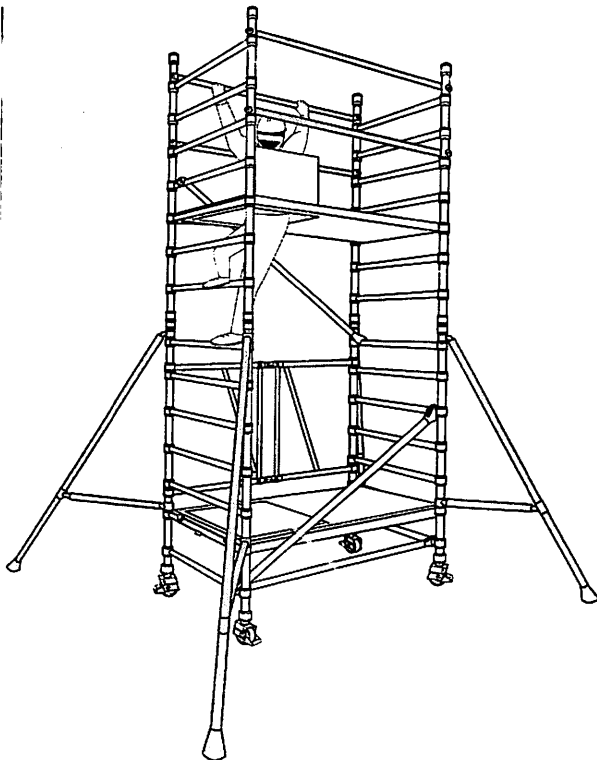

5 Fit a 4 rung guardrail frame to each end of the tower. Ensure the frame interlock clips are engaged

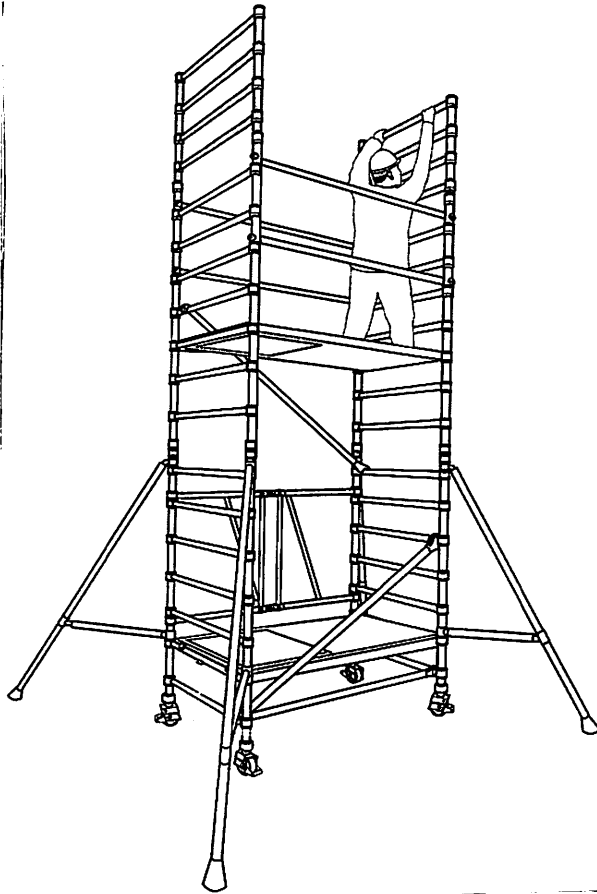

6 The platforms must now be repositioned as follows: Whilst standing on the upper deck, unlatch the 4 guardrail brace hooks furthest from the trapdoor but leave the braces in position. From the protected position of the trapdoor deck, unlatch the remaining 4 brace hooks and remove the 4 guardrail braces and then descend immediately to the lower platform.

NEVER stand on a platform without guardrails.

Remove the platform from the 10th rungs of the tower. Fit a diagonal brace between 7th and 11th rungs of the tower in the opposite direction to the lower diagonal. Reposition the deck from the 2nd rung to the 6th rung of the tower and fully guardrail, as shown.

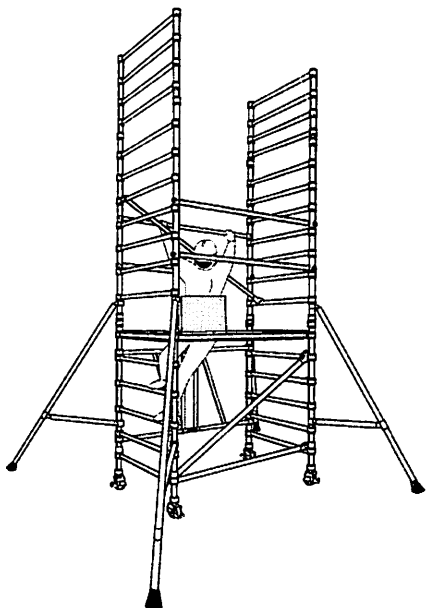

7 Fit a diagonal between the 9th and 13th rungs of the tower. Fit a deck on the 14th rungs of the tower. From the protected position of the trapdoor deck, fit a pair of guardrails 2 and 4 rungs above the platform (16th & 18th rungs of the tower). Fit a diagonal between the 14th and 18th rungs of the tower, as shown. Fit toeboards

The tower is now complete.

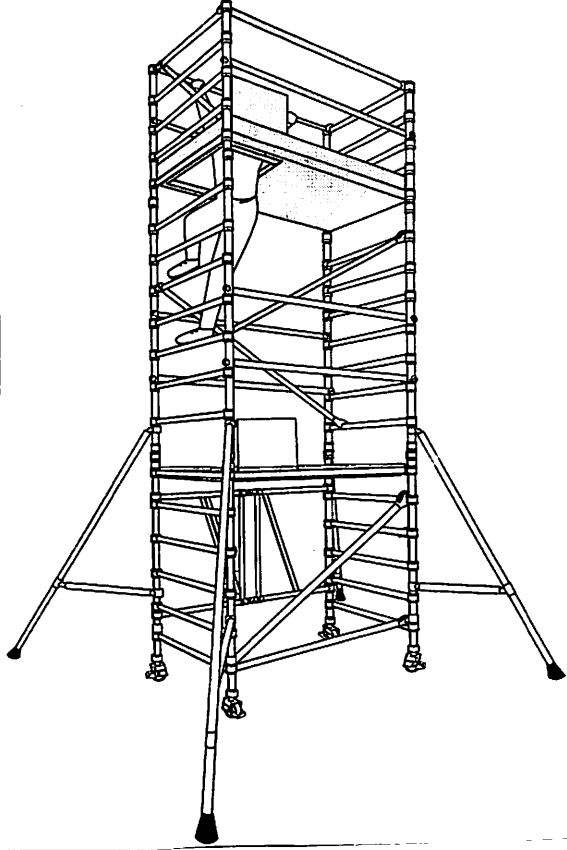

STABILISERS

Mobile Towers - 3T Method

Stabilisers must always be fully extended. Position the lower clamp so that the lower arm is as close to the horizontal as possible. Adjust the position of the top clamp to ensure the stabiliser foot is in firm contact with the ground.